

dji OSMO POCKET 4

Instrukcja szybkiego uruchomienia

Treść ta może ulec zmianie bez uprzedniego powiadomienia.
DJI jest znakiem towarowym firmy DJI. OSMO jest znakiem towarowym firmy DJI OSMO. OSMO POCKET jest znakiem towarowym firmy DJI OSMO.
Copyright © 2025 DJI. Wszelkie prawa zastrzeżone.

1



Dla Standard Combo ^[1]

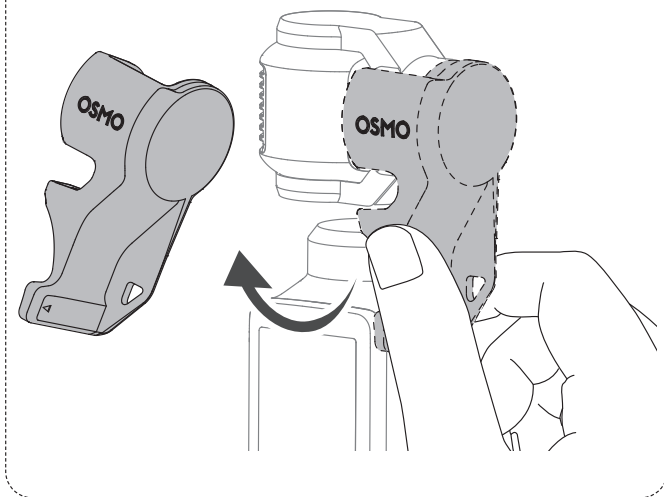

2

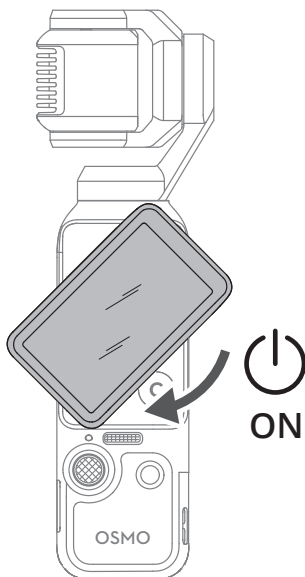

3

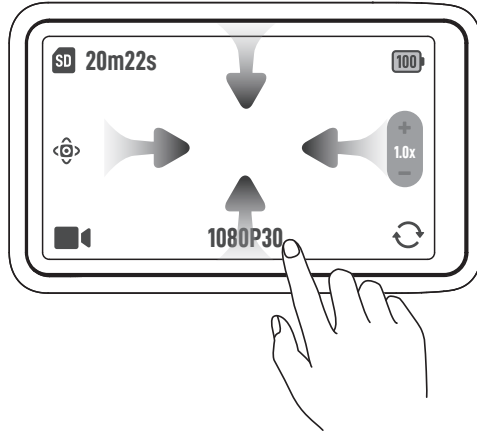

4

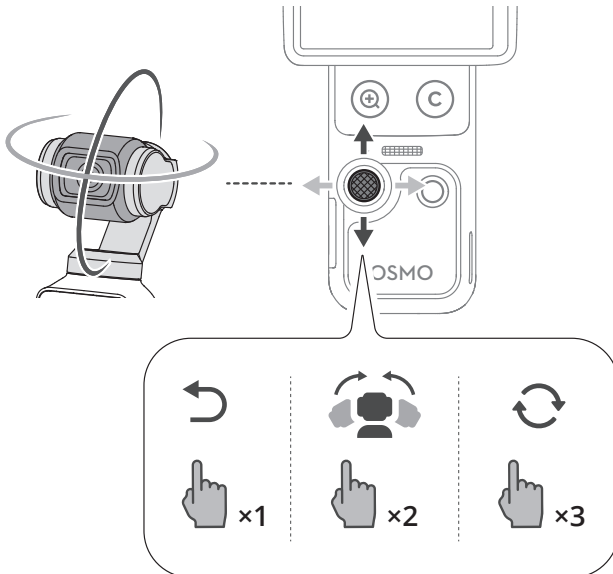

5

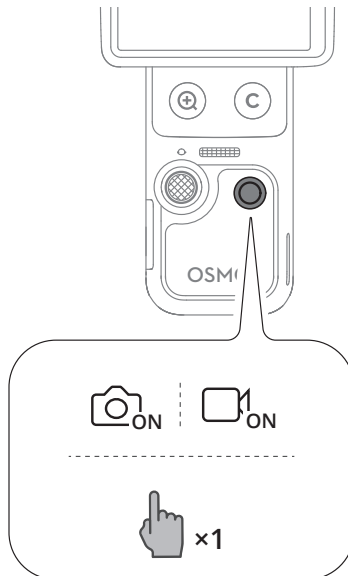
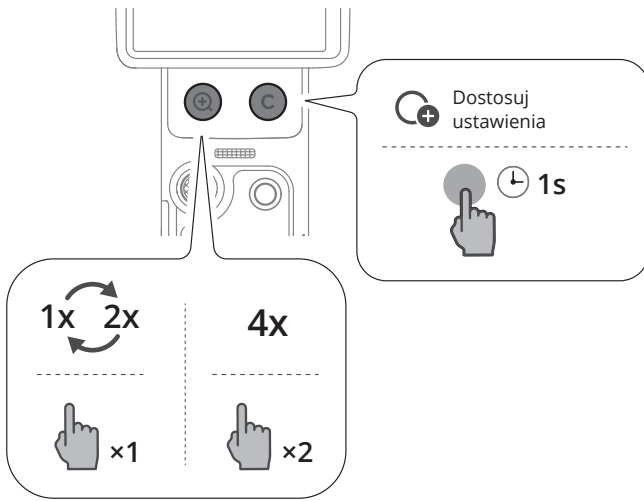

6

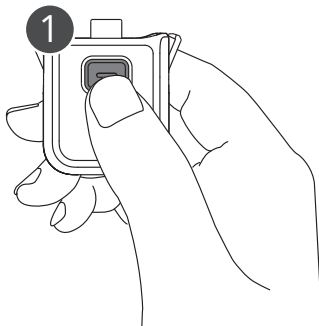
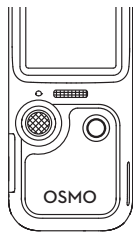
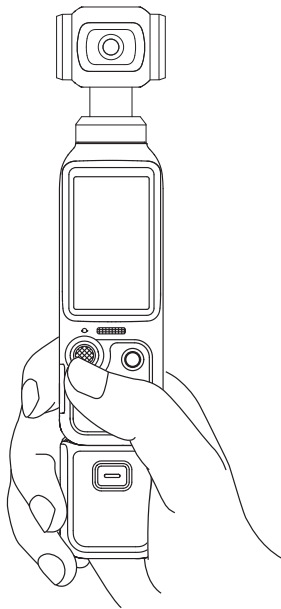

7

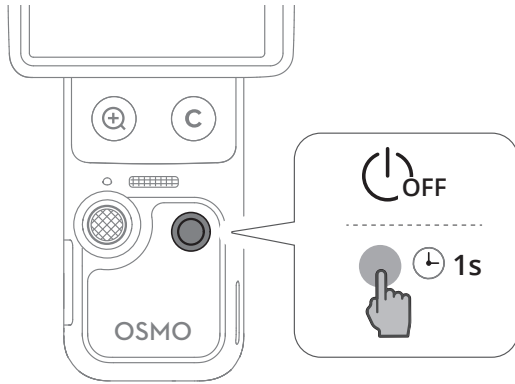

8

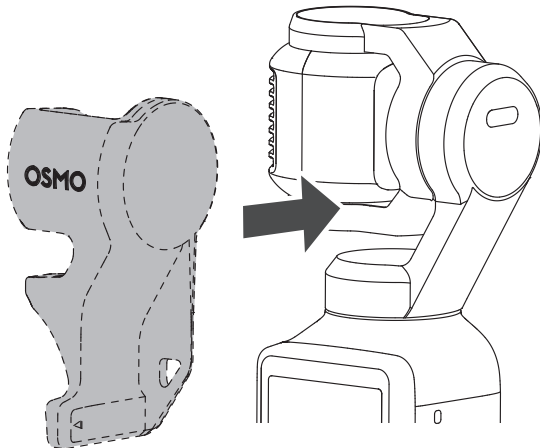

9

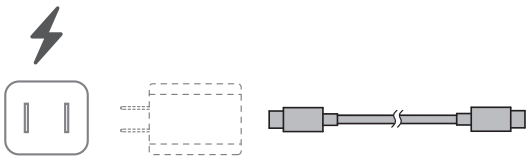
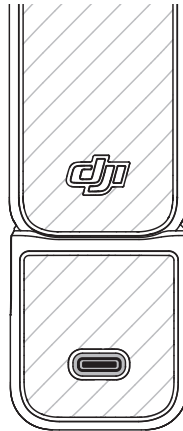
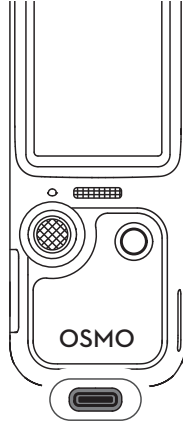

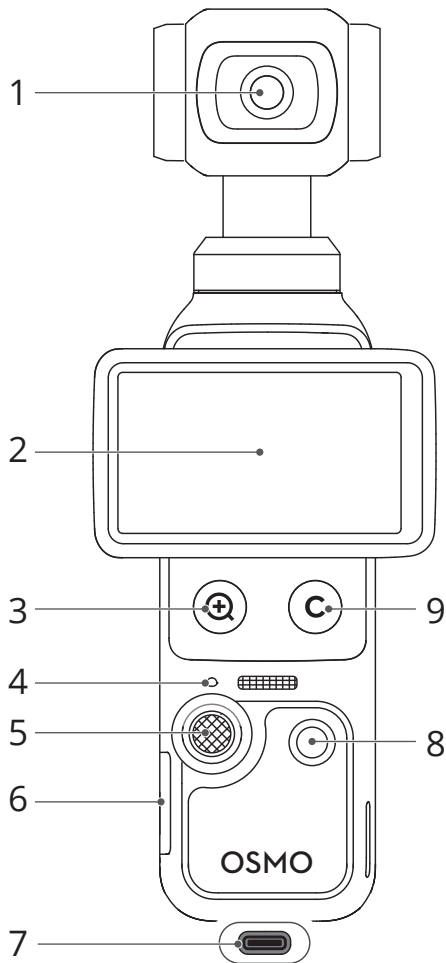

1. Kamera
2. Obracany ekran dotykowy
3. Przycisk powiększenia
4. Wskaźnik LED stanu
5. Joystick 5D
6. Gniazdo karty microSD z pokrywą
7. Port USB-C
8. Przycisk Migawka / Nagrywanie
9. Przycisk niestandardowy (Przytrzymaj, aby dostosować funkcje przycisku)